

Franklin®

BOOKMAN®

ELECTRONIC BOOK CARD

Merriam-Webster®
Speaking
FUN-damental™
Dictionary

USER'S GUIDE

SED-2050

License Agreement

READ THIS LICENSE AGREEMENT BEFORE USING ANY BOOKMAN BOOK CARD.

YOUR USE OF THE BOOKMAN BOOK CARD DEEMS THAT YOU ACCEPT THE TERMS OF THIS LICENSE. IF YOU DO NOT AGREE WITH THESE TERMS, YOU MAY RETURN THIS PACKAGE WITH PURCHASE RECEIPT TO THE DEALER FROM WHICH YOU PURCHASED THE BOOKMAN BOOK CARD AND YOUR PURCHASE PRICE WILL BE REFUNDED. BOOKMAN BOOK CARD means the software product and documentation found in this package and FRANKLIN means Franklin Electronic Publishers, Inc.

LIMITED USE LICENSE

All rights in the BOOKMAN BOOK CARD remain the property of FRANKLIN. Through your purchase, FRANKLIN grants you a personal and nonexclusive license to use the BOOKMAN BOOK CARD on a single FRANKLIN BOOKMAN unit at a time. You may not make any copies of the BOOKMAN BOOK CARD or of the data stored therein, whether in electronic or print format. Such copying would be in violation of applicable copyright laws. Further, you may not modify, adapt, disassemble, decompile, translate, create derivative works of, or in any way reverse engineer the BOOKMAN BOOK CARD. You may not export or reexport, directly or indirectly, the BOOKMAN BOOK CARD without compliance with appropriate governmental regulations. The BOOKMAN BOOK CARD contains Franklin's confidential and propriety information which you agree to take adequate steps to protect from unauthorized disclosure or use. This license is effective until terminated. This license terminates immediately without notice from FRANKLIN if you fail to comply with any provision of this license.

Contents

Merriam-Webster® Speaking Fundamental™ Dictionary is made especially for you, a student in one of the elementary grades. It's easy and fun to use. You will be able to find the definitions and

hear the pronunciations of almost 50,000 words, see pictures of some words, play fun word games with moving pictures, find rhyming words, and see the plurals of nouns and the basic forms of other words.

What the Keys Do	2
How to Get Started	3
How to Change the Letter Size and Brightness	5
How to Look Up a Word	6
If You Misspell a Word	7
How to Hear Words	8
How to See Pictures	9
What Does That Word Mean?	10
It's Time to Rhyme	11
Plurals, Tenses, and Other Word Forms	12
How to Find a Letter in a Word	13
How to Find a Series of Letters	14
How to Look Up Words in Other Books	15
How to Play the Hangman Game	16
How to Play the Word Train™ Game	17
How to Play the Flashcards Game	18
How to Play the Picture Puzzler™ Game	19
How to Take Care of This Dictionary	20
How to Reset BOOKMAN	21
Limited Warranty (U.S. only)	23
Index	25

What the Keys Do

Red, Green, Yellow, and Blue

- FORMS (red)** Shows the forms of a word (noun, verb, etc.).
- SAY (green)** Says a word.
- GAMES (yellow)** Shows the games you can play.
- RHYME (blue)** Shows rhyming words.

► Using the Color Keys

When you are using this dictionary, the red, green, yellow, and blue keys do not do what is printed on the keys.

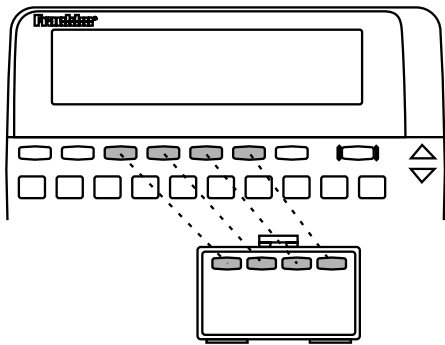

Instead, they do what is printed on the dictionary book card.

Other Keys

- BACK** Deletes the last letter or goes back to the previous screen.
- CAP** Makes a capital letter.
- CARD** Leaves the dictionary.
- CLEAR** Clears the screen and goes back to the *Type a word* screen.
- ENTER** Enters a word or starts a highlight.
- HELP** Shows help messages.
- MENU** Shows the menu.
- ON/OFF** Turns the BOOKMAN on or off.
- ? *** Types a question mark to stand for an unknown letter in a word; with **CAP** types an asterisk to stand for a series of unknown letters.
- SPACE** Types a space or pages down.

Direction Keys

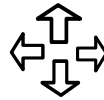

Move in menus and games.



Shows the previous screen.



Shows the next screen.

How to Get Started

Before you can use this dictionary, you have to put it in your BOOKMAN. Follow these steps.

1. Make sure your BOOKMAN is turned off.

This is important! You should never place a book card in your BOOKMAN when it is turned on. If you do, you may damage the book card.

2. Turn your BOOKMAN over.

3. Line up the dictionary book card with a hole on the back.

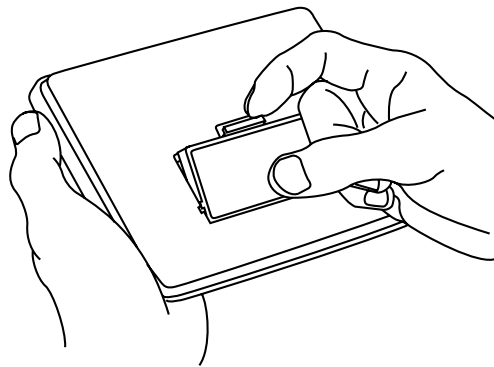

4. Press the book card into the hole.

5. Press **ON/OFF.**

6. Press **CARD.**

7. Press **⇨ to highlight the *Speaking FUN-damental Dictionary*.**



8. Press **ENTER to start using the dictionary.**

How to Get Started

► How Do I Get Around?

Moving around in your new dictionary is easy. Just use the arrow keys to highlight the choice you want, then press **ENTER**.

► Who Turned My Dictionary Off?

To make your batteries last longer, your BOOKMAN is designed to shut off if it is not used in two minutes. Just turn the BOOKMAN back on and the screen you were working on last appears.

► Help is Always at Hand

If you are confused about how to do something, just press **HELP**. A message appears that will help you.

► How It Works

To learn more about how to use this dictionary, press **MENU**. *How It Works* is already highlighted, so press **ENTER**. Use **↓** to read the instructions. To stop, press **CLEAR**.

► See It Work

To see a show about the *Speaking FUN-damental Dictionary*, press **MENU**. Press **↓** to highlight *See It Work* and then press **ENTER**. To stop the show, press **CLEAR**.

How to Change the Letter Size and Brightness

You can change the letter size of the words that appear on the screen. There are three settings.

1. Press **MENU**.
2. Use **↓** to highlight **Change Letter Size**.
3. Press **ENTER** repeatedly until you find a letter size you like.



4. Press **CLEAR** when you are done.

You can also change how bright the screen is, to make the dictionary easier to read.

1. Press **MENU**.
2. Use **↓** to highlight **Change Brightness**.
3. Press **ENTER**.

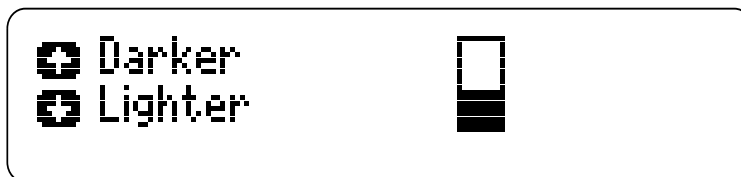

4. Use **↑** or **↓** to make the screen darker or lighter.
5. Press **CLEAR** when you are done.

How to Look Up a Word

It's easy to find the meanings of words with this dictionary. Let's learn how.

1. Press **CLEAR**.

2. Type a word. For example, type the word *jet*.



To type numbers, hold **☆** and press the number keys.

3. Press **ENTER**.

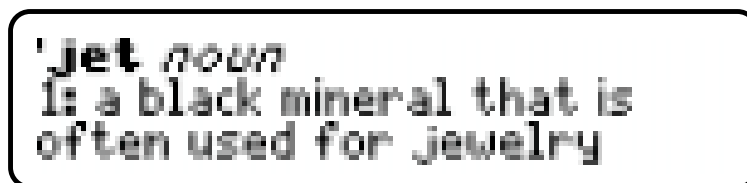

4. Use **↓** **to see more of the word's definition(s).**

You can also see more by holding **CAP** and pressing **DN** repeatedly.

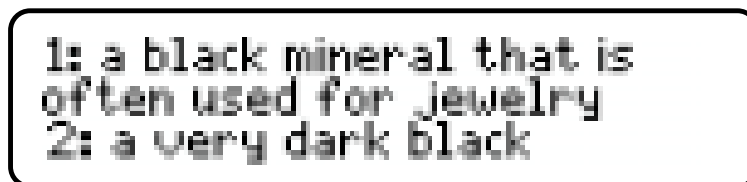

Some words have more than one definition. Some definitions include examples and synonyms.

5. Hold **☆** **and press** **DN** **to see the word's next definition or the word that comes after your word in this dictionary.**

6. Hold **☆** **and press** **UP** **to see the word's previous definition or the word that comes before your word in this dictionary.**

7. Press **CLEAR** **when you are done.**

If You Misspell a Word

If you misspell a word, this dictionary automatically gives you a list of corrections.

1. Press **CLEAR**.

2. Type a misspelled word. For example, type *jiraph*.



To erase a letter, press **BACK**.

3. Press **ENTER**.

The  lets you know the dictionary is looking up the word.

4. Use  to highlight a correction, if needed.

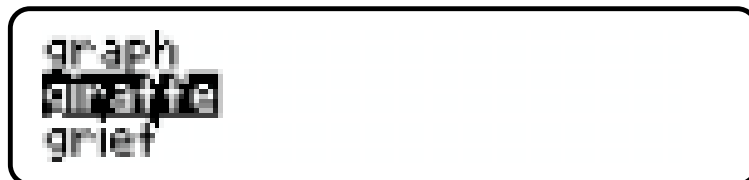

5. Press **ENTER** to see its definition.

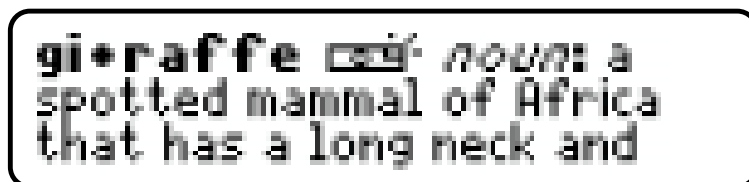

6. To go back to the spelling corrections, press **BACK**.

7. Press **CLEAR** when done.

How to Hear Words

You can hear the pronunciations of most of the words in this dictionary. Let's learn how. Note: You can only hear words if you have a speaking BOOKMAN unit.

1. Press **CLEAR**.

2. Type a word. For example, type *debris*.

Type a word, then **ENTER**:
debris

3. Press the green **SAY** key to hear the word.

4. Press **ENTER** to see the word's definition.

de•bris *noun, plural de•bris*: the junk or pieces left from something broken

5. Press the green **SAY** key to hear the word again.

6. Press **ENTER** to start a highlight.

7. Use **⇨** to highlight a word. For example, highlight *junk*.

de•bris *noun, plural de•bris*: the **junk** or pieces left from something broken

8. Press the green **SAY** key to hear the highlighted word.

9. Press **CLEAR** when you are done.

How to See Pictures





Many of the words in this dictionary have pictures. If a word has a picture, a camera () appears next to it. Some of the pictures even move. To see a picture, all you have to do is highlight the camera and then press **ENTER**.

1. Press **CLEAR**.
2. Type a word. For example, type *swan*.
3. Press **ENTER**.

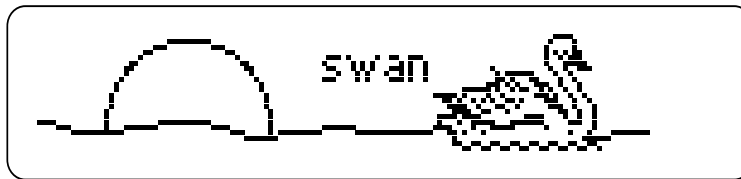
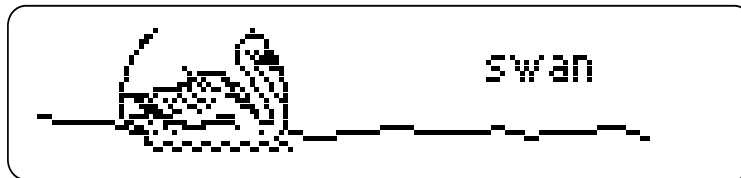
swan  noun: a usually white water bird with a long neck and a heavy body that

4. Hold  and press **ENTER** to highlight the camera.
Or press **ENTER** and then use  to highlight the camera.
5. Press **ENTER** to see a picture of the word.



6. Press **ENTER** to see the picture move again.
You can hold  and press  to see the next picture in this dictionary. Hold  and press  to see the previous picture in this dictionary.
7. Press **BACK** to go back to the definition.
8. Press **CLEAR** when you are done.

What Does That Word Mean?

If you do not know the meaning of a word that you see in a definition, you can use your dictionary to help. Simply highlight that word and look up its definition.

1. Press **CLEAR**.
2. Type a word. For example, type *astronomer*.
3. Press **ENTER** to see its definition.
4. If you want to hear the word, press **SAY**.
5. Press **ENTER** to start a highlight.
6. Use **⇨** to highlight a word. For example, highlight the word *astronomy*.



as•tron•o•mer *noun*: a person who is skilled in astronomy

7. Press **ENTER** to see the definition of the highlighted word.



as•tron•o•my *noun*: the science of celestial bodies and of their motions and

8. Press **BACK** to go back to the original definition.
9. Press **CLEAR** when you are done.

It's Time to Rhyme

You can find words that rhyme with the word you type. Rhymes are words that sound alike.

1. Press **CLEAR**.
2. Type a word. For example, type *sweet*.
3. Press **ENTER**.

```
'sweet adjective  
1: pleasing to the taste  
2: containing or tasting of
```

4. Press the blue **RHYME** key to see a list of words that rhyme with your word.
5. Use **↓** to highlight a word. For example, highlight *beet*.

```
athlete  
beat  
beet
```

6. Press **SAY** to hear the rhyming word.
7. Press **ENTER** to see the word's definition.

```
beet noun: a leafy plant  
with a thick juicy root that  
is used as a vegetable or as
```

8. Press **CLEAR** when you are done.

Plurals, Tenses, and Other Word Forms

You can find the different forms of words with this dictionary. You can find plurals of nouns, comparatives and superlatives of adjectives, basic verb tenses and parts of speech. Here's how.

1. Press **CLEAR**.
2. Type a word. For example, type *mean*.
3. Press the red **FORMS** key.
4. Use **↓** to highlight a word form.



```
mean (verb)
mean (noun)
mean (adjective)
```

5. Press **ENTER**.



```
mean
meaner (more...)
meanest (the most...)
```

6. Press **↓** to see more forms, if any.
7. Press **BACK** to go back to the previous screen.
8. Use **↓** or **↑** to make another choice. For example, highlight *mean (noun)*.
9. Press **ENTER**.



```
mean
means (plural)
```

10. Press **CLEAR** when you are done.

How to Find a Letter in a Word

If you are unsure about a letter in a word, type a question mark in place of each unknown letter. You can type more than one question mark in a word. Try this example.

1. Press **CLEAR**.

2. Type a word with ?'s. For example, type *p?rt*.



Type a word, then **ENTER**:

p?rt

3. Press **ENTER**.

4. Use **↓** to highlight a word, if needed.



part
pert
port

5. Press **ENTER** to see the highlighted word's definition.

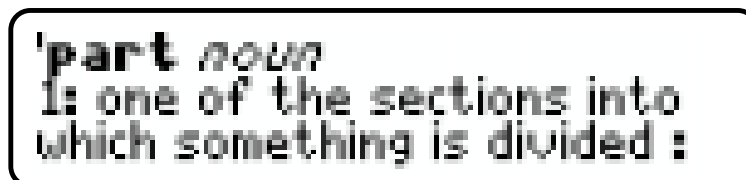

'part noun
is one of the sections into
which something is divided :

6. Press **CLEAR** when you are done.

► Crossword Helper

You can also use question marks to help solve crossword puzzles and similar word games. For example, if the second letter of a five-letter word is h and the last letter is n, type ?h??n and press **ENTER** to see possible answers.

How to Find a Series of Letters

You can also find the endings, beginnings, and other parts of words by typing an asterisk (*). An asterisk stands for a series of letters.

1. Press **CLEAR**.

2. Type a word with an *. For example, type **cl*s**.

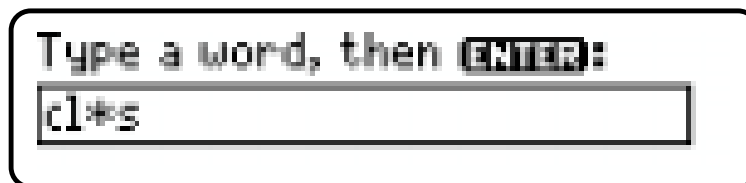

To type an asterisk, hold **CAP** and press **?***.

3. Press **ENTER**.

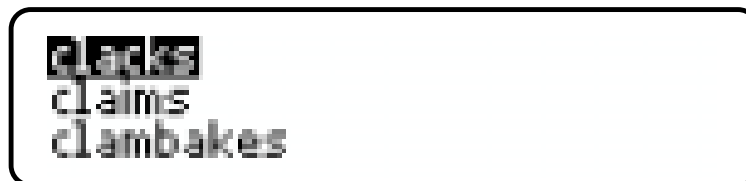

4. Press **↓** to highlight a word.

5. Press **ENTER** to see the highlighted word's definition(s).

6. Press **CLEAR** when you are done.

How to Look Up Words in Other Books

You can look up words from the *Speaking FUN-damental Dictionary* in some other BOOKMAN books—for example, in the *Concise Columbia Encyclopedia*. You can also look up words from other BOOKMAN book cards in this dictionary.

Note: You must have at least one book card installed in your BOOKMAN to look up words between books.

1. Press **CLEAR**.
2. Type a word. For example, type *tiger*.



3. Hold **☆** and press **CARD**.
4. Press **↵** to highlight the symbol of the other book.



We are highlighting the *Concise Columbia Encyclopedia*.

5. Press **ENTER**.
6. If needed, press **ENTER** to look up the word in the other book.
7. Hold **☆** and press **CARD** to go back to the *Speaking FUN-damental Dictionary*.

How to Play the Hangman Game

Hangman challenges you to guess a mystery word one letter at a time. The letters of the mystery words are hidden by question marks. You have a limited number of tries. Wrong guesses take your man one step closer to his doom!

1. Press the yellow **GAMES** key.
2. Press **↓** to highlight Hangman and then press **ENTER**.

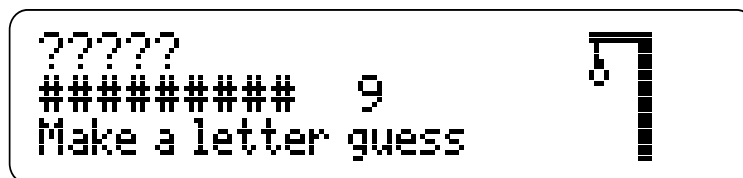

9 = Number of guesses left.

3. Type a letter you think is in the mystery word.
4. Keep typing letters until you win or run out of tries.
To see a hint, press **ENTER**. Note: If you ask for a hint, you will lose the round.
5. Press **?*** to see the word and end the round.
6. Press **SAY** to hear the word.
7. Press **ENTER** to see the definition of the mystery word.
8. Press **BACK** to go back to the game.
9. Press **SPACE** to start a new round.

► How to Change the Skill Level of Hangman

The skill level determines how easy it is to win the game. The beginner level is easier to win than the Wizard level. To change the setting, first press the yellow **GAMES** key. *Set Skill Level* is already highlighted, so press **ENTER**. Then press **↓** repeatedly to highlight the skill level you want to play and press **ENTER**. A check marks your choice.

How to Play the Word Train™ Game

All aboard the Word Train spelling game! You and the train take turns typing letters to form a word. Each word must have at least four letters. Whoever types the last letter wins.

1. Press the yellow **GAMES** key.
2. Use **↓** to highlight *Word Train* from the games list.
3. Press **ENTER**.
4. Type any letter to start a word.
Now the train adds a letter. In the next round the train will start first.
5. Continue typing letters after the train until a word is formed.

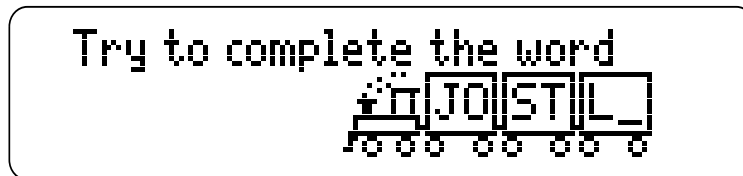

Note: The word formed must be one in this dictionary's word list.

6. Press **ENTER** to see the letters you can type in a boxcar.
7. Press **?*** to see the word and end the round.
8. Press **SAY** to hear the word.
9. Press **ENTER** after the game to see the mystery word's definition.
10. Press **BACK** to go back to the game.
11. Press **SPACE** to start a new round.

► How to Change the Skill Level of Word Train

The skill level determines how easy it is to win Word Train. The beginner level is easier to win than the Wizard level. To change the setting, first press the yellow **GAMES** key. *Set Skill Level* is already highlighted, so press **ENTER**. Then press **↓** repeatedly to highlight the skill level you want to play and press **ENTER**. A check marks your choice.

How to Play the Flashcards Game

Flashcards flashes words for you to define or study. Try reading the word to a friend or have the word read to you. Then try to spell or define the word.

1. Press the yellow **GAMES** key.
2. Use **↓** to highlight *Flashcards* from the games list.
3. Press **ENTER**.

```
blunders
ENTER for definition
ENTER to continue
```

4. Press **ENTER** again to see the word's definition.

```
'blun•der verb
1: to move in a clumsy way
2: to make a mistake
```

5. Press **SAY** to hear the word.
6. Press **BACK** to go back to the game.
7. Press **SPACE** to see another word.

► How to Change the Skill Level of Flashcards

The skill level determines how difficult the Flashcards word is to define. The beginner level uses words that are easier to define than the Wizard level. To change the setting, first press the yellow **GAMES** key. *Set Skill Level* is already highlighted, so press **ENTER**. Then press **↓** to highlight the skill level you want to play and press **ENTER**. A check marks your choice.

How to Play the Picture Puzzler™ Game

Picture Puzzler challenges you to match words and pictures. You will be shown a picture for a little while and must try to come up with the matching dictionary word. Your total score is shown at the top left of the game screen. Each incorrect letter choice will deduct \$10 from your prize amount.

1. Press the yellow **GAMES** key.
2. Use **↓** to highlight *Picture Puzzler* from the games list.
3. Press **ENTER**.

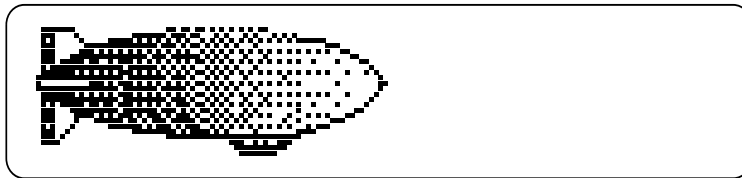

4. Type a letter you think is in the mystery word.

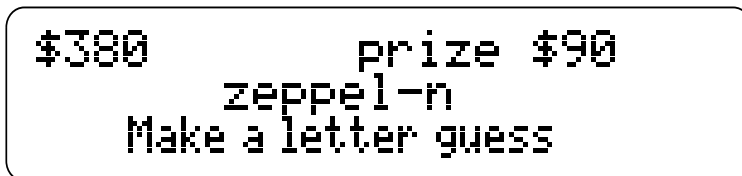

Keep entering letters until you win or run out of tries.

5. Press **ENTER** to see the picture again.
6. Press **?*** to see the mystery word and end the round.
7. Press **ENTER** after a round to see the definition(s) of the mystery word.
8. Press **SAY** to hear the word.
9. Press **BACK** to go back to the game.
10. Press **SPACE** to start another round.

Note: Skill levels do not affect Picture Puzzler.

How to Take Care of This Dictionary

Do not touch the metal parts of the book card.

This is important! If you touch the metal parts of the card with metal objects or objects charged with static electricity, including your fingers, you might erase information or damage the book card.

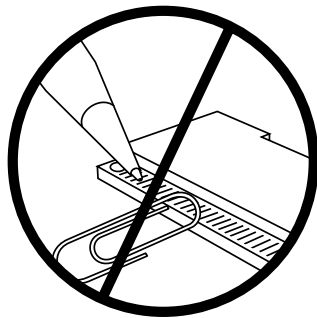

Do not put weight on the book card.

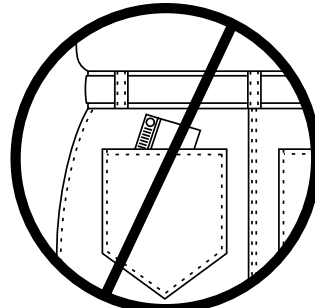
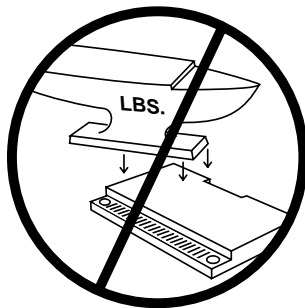

Do not leave the book card in hot, cold, or wet places.

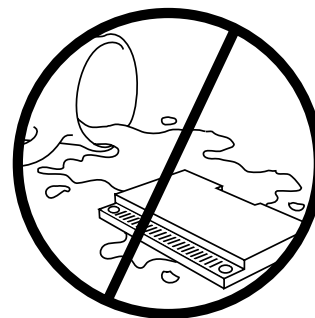
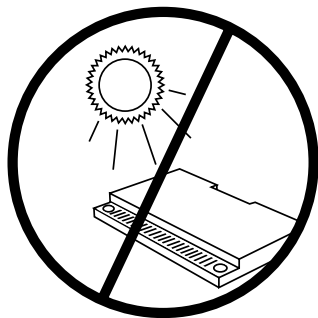

How to Reset BOOKMAN

If the BOOKMAN keyboard fails to respond, or if its screen performs erratically, first press **CLEAR** and then press **ON/OFF** twice. If nothing happens, follow the steps below to reset it.

Warning: Pressing the reset button with more than very light pressure may permanently disable your BOOKMAN. In addition, resetting your BOOKMAN unit erases settings and information entered into its built-in book card, and in an installed book card.

1. Hold **CLEAR and press **ON/OFF**.**

If nothing happens, try Step 2.

2. Use a paper clip to *gently* press BOOKMAN's reset button.

This unit may change operating modes due to Electro-static Discharge. Normal operation of this unit can be re-established by pressing the reset key, **ON/OFF**, or by removing or replacing the batteries.

► **Troubleshooting BOOKMAN**

- Make sure your book card, if any, is installed correctly.
- Check that your book card's metal contacts are dirt- and dust-free.

Specifications

Model SED-2050

Speaking FUN-damental™ Dictionary, Merriam-Webster®

- size: 5.9 x 4.2 x 0.6 cm

- weight: 0.4 oz

© 1996 Franklin Electronic Publisher, Inc., Burlington, NJ 08016-4907 U.S. All rights reserved.

© 1996 Merriam-Webster, Inc. All rights reserved.

© 1995 First Byte, Inc. All rights reserved.

Merriam-Webster is a registered trademark of Merriam-Webster, Inc.

FCC Notice: Complies with the limits for a Class B computing device pursuant to Subpart B of part 15 of FCC Rules. Operation is subject to the following two conditions: (1) This device may not cause harmful interference; and (2) This device must accept any interference received, including interference that may cause undesired operation.

U.S. Patents 4,490,811; 5,113,340; 5,321,609; 5,218,536; 4,830,618;

5,396,606; 4,891,775; 5,333,313; 4,406,626; 5,229,936; 5,007,019; 5,153,831.

European Patent 0 136 379.

Deutsch Pats. M 9409743.7 and M 9409744.5

Patents Pending.

ISBN 1-56712-276-0.

Limited Warranty (u.s. only)

FRANKLIN warrants to you that the BOOKMAN PRODUCT will be free from defects in materials and workmanship for one year from purchase. In the case of such a defect in your BOOKMAN PRODUCT, FRANKLIN will repair or replace it without charge on return, with purchase receipt, to the dealer from which you made your purchase or Franklin Electronic Publishers, Inc., One Franklin Plaza, Burlington, New Jersey 08016-4907, within one year of purchase. Alternatively, FRANKLIN may, at its option, refund your purchase price.

Data contained in the BOOKMAN PRODUCT may be provided under license to FRANKLIN. FRANKLIN makes no warranty with respect to the accuracy of data in the BOOKMAN PRODUCT. No warranty is made that the BOOKMAN PRODUCT will run uninterrupted or error free. You assume all risk of any damage or loss from your use of the BOOKMAN PRODUCT.

This warranty does not apply if, in the sole discretion of FRANKLIN, the BOOKMAN PRODUCT has been tampered with, damaged by accident, abused, misused, or misapplication, or as a result of service or modification by any party, including any dealer, other than FRANKLIN. This warranty applies only to products manufactured by or for FRANKLIN. Batteries, corrosion, or battery contacts and any damage caused by batteries are not covered by this warranty. NO FRANKLIN DEALER, AGENT, OR EMPLOYEE IS AUTHORIZED TO MAKE ANY ADDITIONAL WARRANTY IN THIS REGARD OR TO MAKE ANY MODIFICATION OR EXTENSION OF THIS EXPRESS WARRANTY.

THE FOREGOING WARRANTY IS EXCLUSIVE AND IS IN LIEU OF ALL OTHER EXPRESS OR IMPLIED WARRANTIES, WRITTEN OR ORAL, INCLUDING, BUT NOT LIMITED TO, WARRANTIES OF MERCHANTABILITY OR FITNESS FOR A PARTICULAR PURPOSE. YOUR SOLE AND EXCLUSIVE REMEDY SHALL BE FRANKLIN'S OBLIGATION TO REPLACE OR REFUND AS SET FORTH ABOVE IN THIS WARRANTY. Some States do not allow the exclusion of implied warranties, or limitations on how long a warranty lasts. This warranty gives you specific rights; you may also have additional rights which vary from State to State. This warranty shall not be applicable to the extent that enforcement of any provision may be prohibited by applicable law.

FRANKLIN SHALL IN NO EVENT BE LIABLE TO YOU OR TO ANY OTHER PERSON FOR ANY SPECIAL, INCIDENTAL, OR CONSEQUENTIAL DAMAGES, OR ANY OTHER INDIRECT LOSS OR DAMAGE, ARISING OUT OF YOUR PURCHASE, THE MANUFACTURE OR SALE OF THE BOOKMAN PRODUCT, THIS LICENSE, OR ANY OBLIGATION RESULTING THEREFROM OR THE USE OR PERFORMANCE OF THE BOOKMAN PRODUCT UNDER ANY LEGAL THEORY, WHETHER BREACH OF CONTRACT, TORT, STRICT LIABILITY OR ANY OTHER CAUSE OF ACTION OR PROCEEDING, WHICH DAMAGES SHALL INCLUDE, BUT NOT BE LIMITED TO, LOST PROFITS, DAMAGES TO PROPERTY, OR PERSONAL INJURY (BUT ONLY TO THE EXTENT PERMITTED BY LAW). FRANKLIN'S ENTIRE LIABILITY FOR ANY CLAIM OR LOSS, DAMAGE, OR EXPENSE FROM ANY SUCH CAUSE SHALL IN NO EVENT EXCEED THE PRICE PAID FOR THE BOOKMAN PRODUCT. THIS CLAUSE SHALL SURVIVE FAILURE OF AN EXCLUSIVE REMEDY. This license and warranty is governed by the laws of the United States and the State of New Jersey.

Index

- ?* key 2, 13, 14
- Arrow keys 2, 4
- Asterisks, searching with 14
- Auto shut-off 4
- Blue (RHYME) key 2, 11
- Book card care 20
- BOOKMAN**
 - resetting 21
 - troubleshooting 21
- CAP key 2**
- CARD key 2, 3**
- Changing brightness 5
- Changing letter size 5
- CLEAR key 2**
- Copyrights and trademarks 22
- Correction list 7
- Crossword helper 13
- DN key 2**
- ENTER key 2**
- FCC notice 22**
- Flashcards**
 - changing skill level 18
 - playing 18
- FORMS (red) key 2, 12**
- GAMES (yellow) key 2, 16, 17, 18, 19**
- Getting started 3**
- Green (SAY) key 2, 8**
- Hangman**
 - changing skill level 16
 - playing 16
- Hearing words**
 - in definitions 8
 - in games 16, 17, 18, 19
 - in lists 11
- Help messages 4**
- Highlighting words in definitions 10**
- How It Works 4*
- Key guide 2**
- Limited Warranty 23**
- Looking up words 6**
- MENU key 2**
- Misspellings, correcting 7**
- Moving around 4**
- ON/OFF key 2, 3**
- Patents 22**
- Picture Puzzler**
 - changing skill level 19
 - playing 19

Index

Pictures

moving 9

viewing 9

Plurals 12

Question marks, searching with 13

Red (FORMS) key 2, 12

RHYME (blue) key 2, 11

Rhyming words, finding 11

SAY (green) key 2, 8

See It Work 4

Size and weight 22

SPACE key 2

UP key 2

Verb tenses 12

Viewing pictures 9

Warranty 23

What the keys do 2

Word forms, finding 12

Word Train

changing skill level 17

playing 17

Words

hearing 8

looking up 6

Yellow (GAMES) key 2, 16, 17, 18

Franklin[®]
Electronic Publishers